

PRIOCOVER

Mobile fire enclosure

Containment of the fire hazard caused by lithium-ion batteries

For batteries of different size and form



PRIOCOVER – When simplicity has priority!

Mobile fire enclosure for containment of the fire hazard caused by lithium-ion batteries



The economic success of companies depends, among other things, on ensuring damage-free operation. The risk of fire in the company can be countered effectively through preventive fire protection measures.

In particular, this also applies to the storage of rechargeable lithium batteries in production or storage areas. Lithium batteries are highly efficient energy storage devices, which are suitable for diverse areas of use, especially in industry. Alongside its many advantages, this technology involves risks.

Technical defects or improper handling during storage, charging and operation can quickly lead to a fire.

Against the background of increasing use of lithium-ion batteries, simple solutions for safe storage are in demand.

Danger always occurs if lithium batteries discharge their stored energy in an uncontrolled way. The resulting, no longer controllable, chain reaction causes an explosive fire. This so-called thermal runaway is difficult to control. It cannot be simply extinguished with water. However, use of large quantities of water is advantageous to lessen the effects and to prevent spreading to other cells.

Excerpt from the “General safety rules according to performance classes (VdS 3103: 2019-06)”



- Damaged or defective lithium batteries must be removed from storage or production areas immediately and stored temporarily at a safe distance or in an area separated by fire resistant construction elements until their disposal.

Fireproof containment of lithium batteries

- Protection of production and storage areas against the effects of a fire
- Fireproof separation of lithium batteries from other stored goods
- Separate, safe storage of damaged batteries
- Targeted cooling with water possible via optionally available connection
- Safe charging of battery systems via optionally available cable penetration seal

“In the view of the property insurer, Lithium batteries are potentially to be classified as a hazard...”

Carsten Tormöhlen, Allianz Deutschland AG



Easy handling

Stable under pressure

Fire resistant design

PRIOCOVER

Mobile fire enclosure

Universally usable pop-over enclosure for comprehensive fire protection in case of active or passive storage of lithium-ion batteries. The enclosure is open at the bottom and is fitted with stable corner angles. The lifting eyebolts enable easy transport and easy moving into position. The enclosure can also be popped over the batteries when they begin to burn. The fire enclosure has a fire resistance rating of 90 minutes.

Function

- Non-combustible incl. decorative surface, A2-s1,d0
- Fire resistant design – 90-minute fire resistance
- Stable under pressure
- Mechanical pressure relief
- Report of an accredited material test institute
- Suitable for passive and active storage

User friendly

- Easy handling
- Mobile, simple solution
- No time-consuming transfer of the batteries into safety cabinets
- Easy to pop over filled pallets
- Fast moving into position by forklift truck
- Easy transport by means of lifting eyes
- Corner angle edge protection
- Space saving, as stackable
- Standard size for covering a euro-pallet 1200 x 800
- Covering of pallets, containment trays or cages
- Placement directly on existing floor

Robust and durable

- Solid construction
- Edge and corner protection
- High degree of stability
- High surface hardness
- High chemical resistance
- Scratch resistant
- Stain resistant
- Single layer wall – wall thickness 42 mm

Sustainability

- Recyclable
- Green building declaration in accordance with LEED and DGNB
- Contaminant-free



Material properties

- Construction material with surface coating on both sides, classified A2 – s1, d0: non-combustible
- Standard surface CPL
- Standard colour light grey, similar to RAL 7035

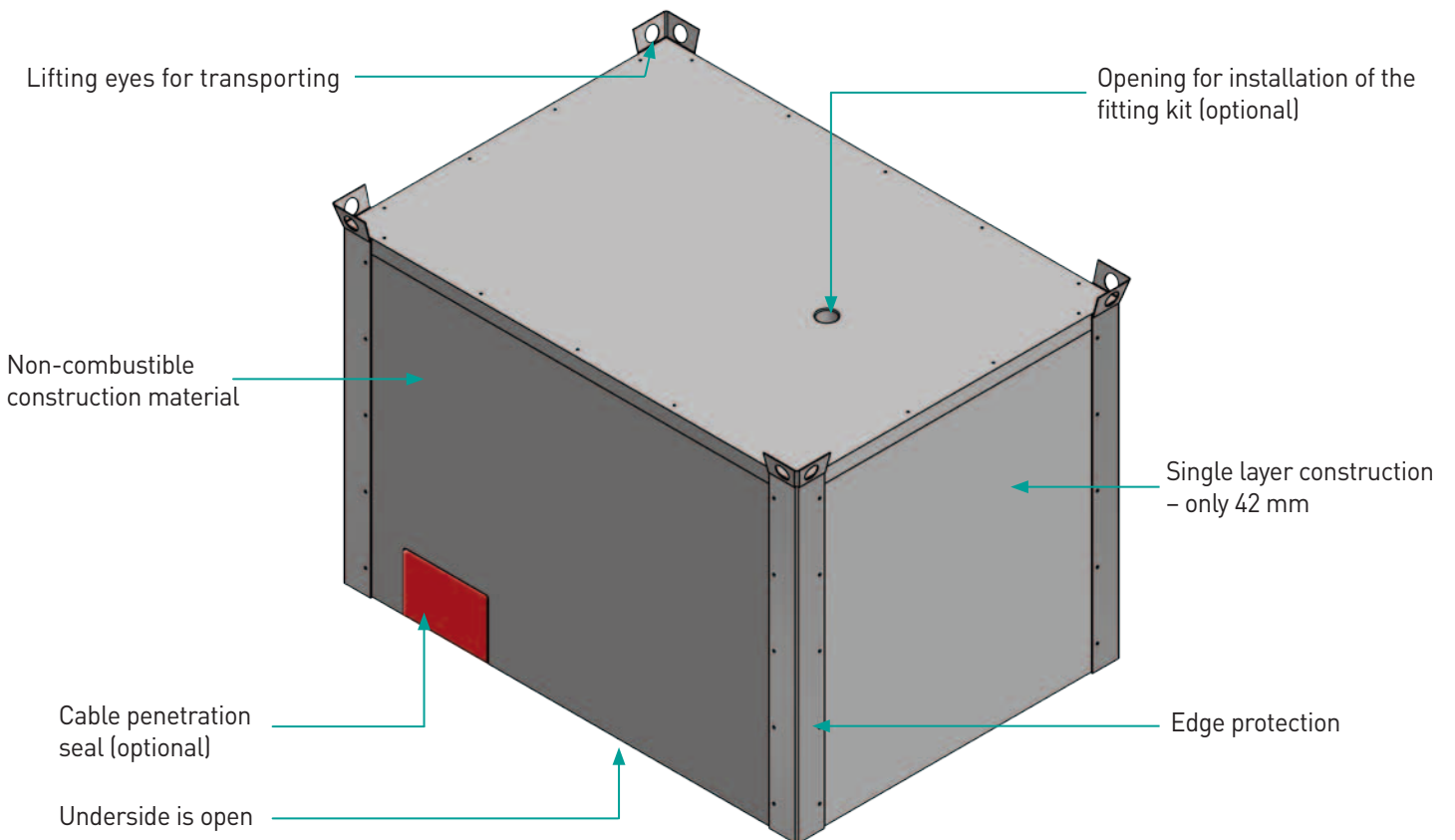
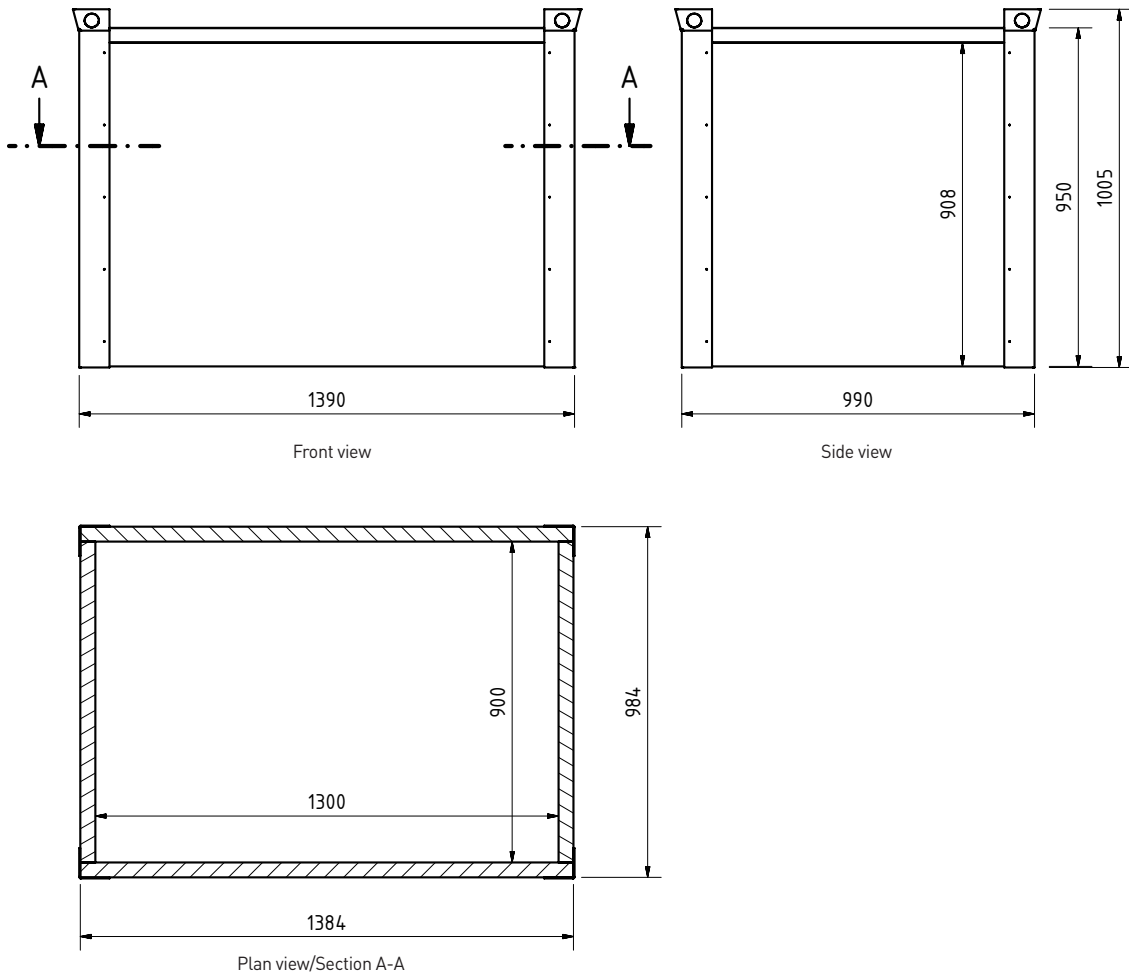
Technical drawing



Article table

Art.	 H x W x D mm	 H x W x D mm	 kg	Description
------	--	--	---	-------------

Standard type

PC.138.098.095	908 x 1300 x 900	1005 x 1390 x 990	400	
----------------	------------------	-------------------	-----	--

Other sizes on request

Tender specification text and current price list: www.priorit.de

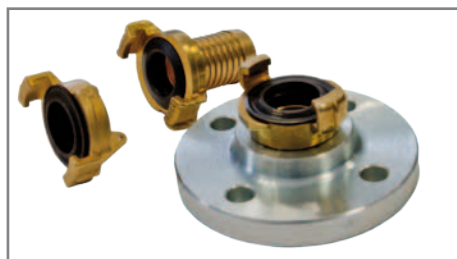

Optional types



PRIOCOVER including fitting kit for a cooling water connection



PRIOCOVER including cable penetration seal for safe charging. The charging cables can remain on the floor. A firestop block safely seals the cables.

Art.	 H x W x D mm	 H x W x D mm	 kg	Description
------	--	--	---	-------------

Optional types

PC.138.098.095.F	908 x 1300 x 900	1005 x 1390 x 990	400	Enclosure incl. fitting kit
PC.138.098.095.KE	908 x 1300 x 900	1005 x 1390 x 990	400	Enclosure incl. cable penetration seal
PC.138.098.095.F.KE	908 x 1300 x 900	1005 x 1390 x 990	400	Enclosure incl. fitting kit and cable penetration seal

Other sizes on request

Accessories

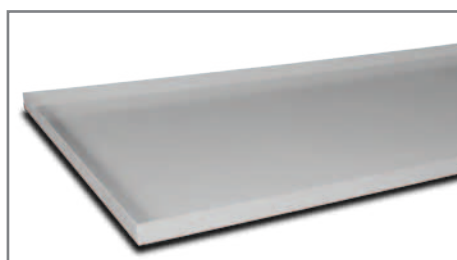

Floor containment tray for holding any material from leaking batteries/rechargeable batteries



Lifting kit - consisting of 2 round slings and 4 spring hooks for easy and safe lifting, transporting and lowering the pop-over enclosure

Art.	Description
------	-------------

Accessories

PC.RS.SET	Lifting kit - consisting of 2 round slings and 4 spring hooks
PC.TRAY	Floor containment tray

Simple – Mobile – Safe

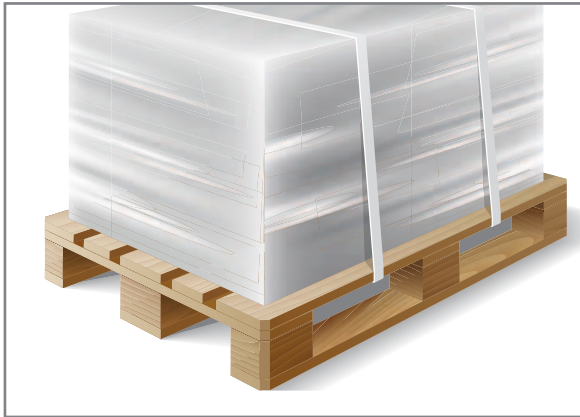

- Lithium-ion batteries can remain directly on a pallet
- No time-consuming transferring or re-arranging of the rechargeable batteries/batteries in safety cabinets
- Damaged batteries can be placed on a pallet and stored safely until they are disposed of.

- Easy transport of the mobile fireproof enclosure with a forklift track within the storage and production areas
- Safe lifting by means of lifting eyes and optionally available round slings.
- No need to move the pallets



- Easy placement of the mobile fireproof enclosure directly on the existing building floor
- Precise-fitting popping over a filled pallet, containment tray or cage
- Standard sizes for euro pallet with dimensions 1200 x 800 mm

- Placement on the existing building floor
- Stable under pressure
- Fire resistant design
- Can also be popped over as a fire begins

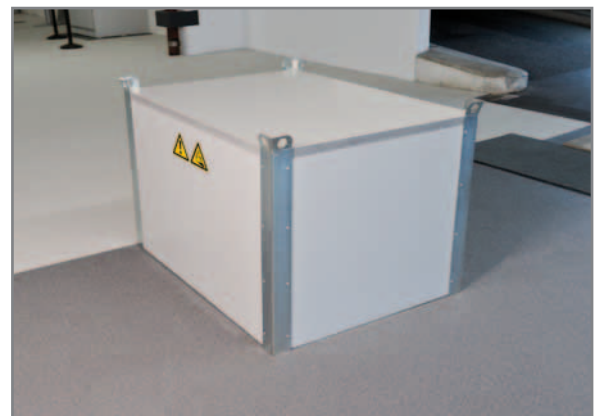

How lithium batteries cause fires

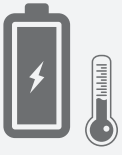

Overheating during charging



Incorrect chargers or overcharging



Deep discharge



Mechanical damage



High ambient temperature

14.06.2019 | www.br.de

Rechargeable batteries caused fire in Würth an der Isar, says recycling company

19.08.2019 | Frankfurter Allgemeine

„Batteries cause a fire each and every week“

09.03.2018 | www.tag24.de

**Damage running into millions!
A rechargeable battery factory in Ölbronn-Dürrn burns down**

Production and safety

ISO 9001 certification provides certainty. All development and production processes of PRIORIT fire protection products comply with internationally recognised rules. You can rely on this! That is certain!

PRIORIT AG
Technologiepark Hanau
Margarete-von-Wrangell-Straße 23
D-63457 Hanau-Wolfgang

Tel: +49 6181 3640-0
Fax: +49 6181 3640-210

info@priorit.de
www.priorit.de

